

Description

Q-Tech's surface mount 5 X 7 mm oscillator series consist of an IC 5Vdc, 3.3Vdc, 2.5Vdc, 1.8Vdc clock square wave generator and a miniature strip AT quartz crystal built in a low profile ceramic package with thru-hole, formed lead, or gull wing. This is the smallest package Q-Tech has ever offered for High Reliability applications.. The lead forming can provide a solution for many applications that require additional lead attachment from an outside subcontractor.

Features

- Made in the USA
- ECCN: EAR99
- Broad frequency range from 300kHz to 160MHz
- Small footprint
- LVHCMOS, HCMOS, and TTL compatible
- 5.0Vdc, 3.3Vdc, 2.5Vdc, 1.8Vdc supply
- Able to meet 36000G shock, half sine, 0.5ms
- Wide operating temperature range
- Tri-State Output (Option D)
- Hermetically sealed ceramic package
- Fundamental and 3rd Overtone designs
- Full or partial military screening tests available
- Tape and reel packaging
- Lead free tinning available
- RoHS compliant 

Applications

- Designed to meet today's requirements for low voltage applications
- High shock applications
- Gun launched munitions and systems
- Smart munitions
- Instrumentation
- Navigation
- Avionics
- Microprocessor clock

Ordering Information

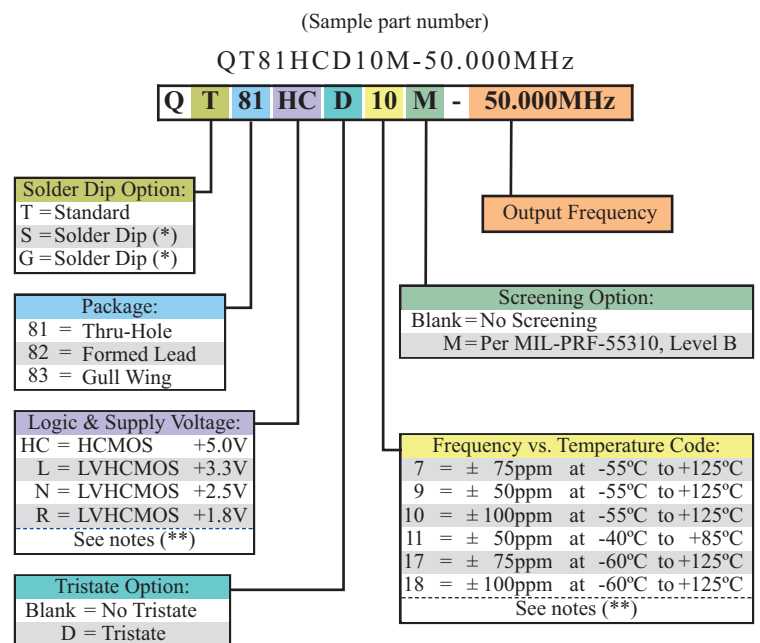

Available for temperatures up to +200°C with Q-Tech MCM number.

(*) Hot Solder Dip options for an additional cost:

S = Sn60/Pb40 per MIL-PRF 55310

G = Lead free Alloy SAC305 (96.5% Sn, 3% Ag, 0.5% Cu)

(**) Notes

- Supply voltage, frequency stability vs. temperature codes may not be available in all frequencies.
- For Non-Standard requirements, contact Q-Tech Corporation at Sales@Q-Tech.com

Specifications subject to change without prior notice.



Electrical Characteristics

Parameters	HC	L	N	R
Output frequency range (Fo)	300kHz — 50.000MHz	300kHz — 160.000MHz	300kHz — 133.000MHz	300kHz — 100.000MHz
Supply voltage (Vdd)	5.0Vdc ± 10%	3.3Vdc ± 10%	2.5Vdc ± 10%	1.8Vdc ± 10%
Maximum Applied Voltage (Vdd max.)	7.0Vdc	5.0Vdc		
Frequency stability (ΔF/ΔT)	See Option codes			
Operating temperature (Topr)	See Option codes			
Storage temperature (Tsto)	-62°C to + 125°C			
Operating supply current (Idd) (No Load)	20 mA max. - 300kHz ~ < 16MHz 25 mA max. - 16MHz ~ < 32MHz 35 mA max. - 32MHz ~ < 50MHz	6 mA max. - 300kHz ~ < 16MHz 10 mA max. - 16MHz ~ < 32MHz 20 mA max. - 32MHz ~ < 60MHz 30 mA max. - 60MHz ~ < 100MHz 40 mA max. - 100MHz ~ < 130MHz 50 mA max. - 130MHz ~ ≤ 160MHz	6 mA max. - 300kHz ~ < 40MHz 15 mA max. - 40MHz ~ < 60MHz 25 mA max. - 60MHz ~ < 85MHz 35 mA max. - 85MHz ~ ≤ 133MHz	4 mA max. - 300kHz ~ < 40MHz 10 mA max. - 40MHz ~ < 50MHz 20 mA max. - 50MHz ~ < 85MHz 25 mA max. - 85MHz ~ ≤ 100MHz
Symmetry (50% of output waveform or 1.4Vdc for TTL)	45/55% max. - 300kHz ~ < 21MHz 40/60% max. - 21 ~ ≤ 50MHz	45/55% max. - 300kHz ~ < 21MHz 40/60% max. - 21 ~ ≤ 160MHz	45/55% max. - 300kHz ~ < 21MHz 40/60% max. - 21 ~ ≤ 133MHz	45/55% max. - 300kHz ~ < 21MHz 40/60% max. - 21 ~ ≤ 100MHz
Rise and Fall times (with typical load)	6ns max. - Fo < 40MHz 3ns max. - Fo ≥ 40 - 50MHz (between 10% to 90%)	6ns max. - 300kHz ~ < 40MHz 3ns max. - 40 ~ ≤ 160MHz (between 10% to 90%)	5ns max. - 300kHz ~ < 40MHz 3ns max. - 40 ~ ≤ 133MHz (between 10% to 90%)	5ns max. - 300kHz ~ < 40MHz 3ns max. - 40 ~ ≤ 100MHz (between 10% to 90%)
Output Load	15pF // 10kohms 50pF max. or 10TTL	15pF // 10kohms (30pF max. for F ≤ 50MHz)	15pF // 10kohms	
Start-up time (Tstup)	10ms max.			
Output voltage (Voh/Vol)	0.9 x Vdd min.; 0.1 x Vdd max.	0.9 x Vdd min.; 0.1 x Vdd max.		
Output Current (Ioh/Iol)	± 24mA max.	± 4mA max.		
Enable/Disable Tristate function Pin 1	VIH ≥ 2.2V Oscillation; VIL ≤ 0.8V High Impedance		VIH ≥ 0.7 x Vdd Oscillation; VIL ≤ 0.3 x Vdd High Impedance	
Jitter RMS 1σ (at 25°C)	See Page 5			
Aging (at 70°C)	± 5ppm max. first year / ± 2ppm max. per year thereafter			

Package Outline and Pin Connections

Dimensions are in inches (mm)

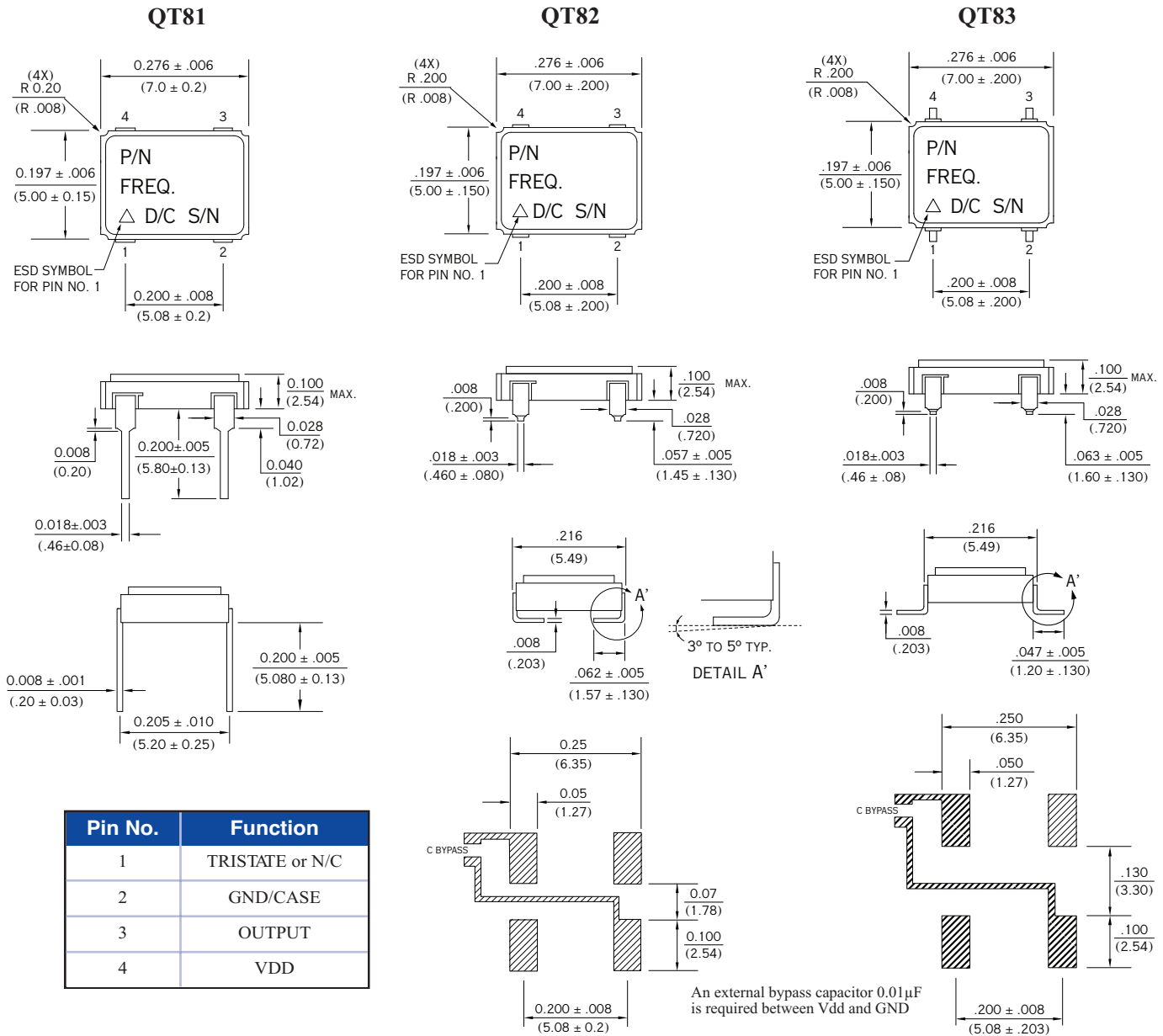

Pin No.	Function
1	TRISTATE or N/C
2	GND/CASE
3	OUTPUT
4	VDD

Package Information

- Package material: 91% AL₂O₃
- Weight: .15g typ., 2g max.
- Lead material: Kovar
- Lead finish: Nickel Underplate: 100μ ~ 250μ inches
Gold Plated: 50μ ~ 80μ inches
Hot Solder Dip Sn60/Pb40 Finish (optional per P.O)
Lead Free Tinning (SAC305) finish (optional per P.O)

Marking Information

- Line 1: P/N (QT81L9M)
- Line 2: Frequency (500.000K)
- Line 3: ESD Symbol + D/C (YYWW) + S/N

Output Waveform (Typical)

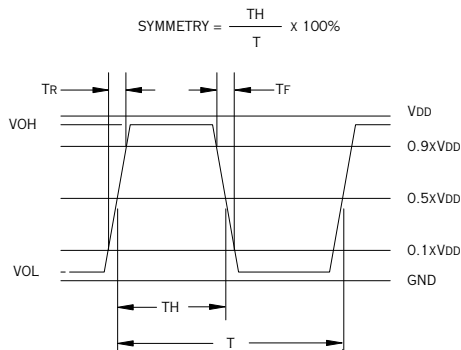

Frequency vs. Temperature Curve

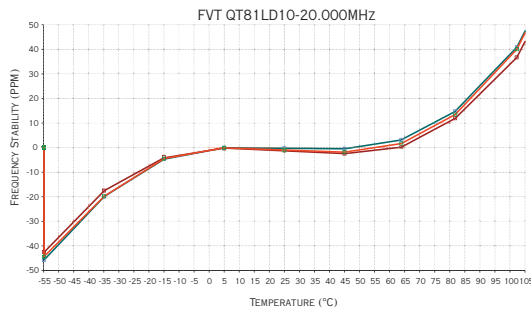

Reflow Profile

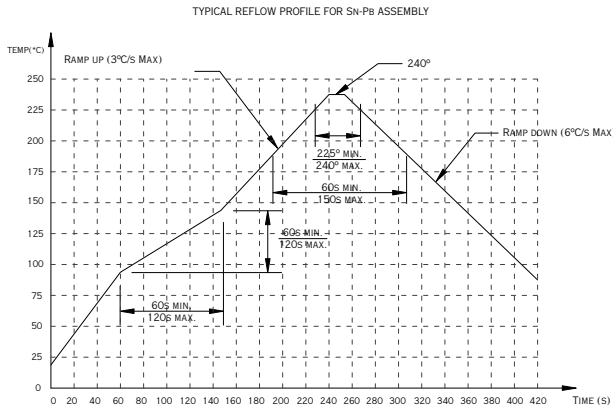

Environmental and Mechanical Specifications

Environmental Test	Test Conditions
Temperature cycling	MIL-STD-883, Method 1010, Cond. B
Constant acceleration	MIL-STD-883, Method 2001, Cond. A, Y1
Seal: Fine and Gross Leak	MIL-STD-883, Method 1014, Cond. A and C
Vibration sinusoidal	MIL-STD-202, Method 204, Cond. D
Shock, non operating	MIL-STD-202, Method 213, Cond. I
Resistance to solder heat	MIL-STD-202, Method 210, Cond. B
Resistance to solvents	MIL-STD-202, Method 215
Solderability	MIL-STD-202, Method 208
ESD Classification	MIL-STD-883, Method 3015, Class 1 HBM 0 to 1,999V
Moisture Sensitivity Level	J-STD-020, MSL=1

Test Circuit

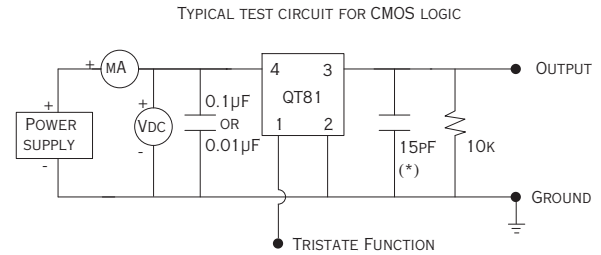

(* CL INCLUDES PROBE AND JIG CAPACITANCE)

The Tristate function on pin 1 has a built-in pull-up resistor so it can be left floating or tied to Vdd without deteriorating the electrical performance.

Embossed Tape and Reel Information for QT82

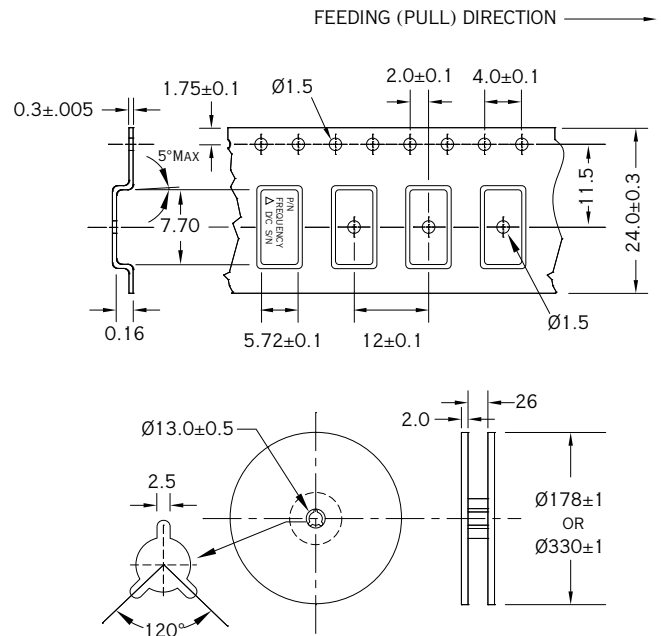

Dimensions are in mm. Tape is compliant to EIA-481-A.

Reel size (Diameter in mm)	Qty per reel (pcs)
178	1,000

Jitter And Phase Noise

As data rate increases, effect of jitter becomes critical with its budget tighter. Jitter is the deviation of a timing event of a signal from its ideal position. Jitter is complex and is composed of both random jitter (RJ) and deterministic jitter (DJ) components.

Random Jitter (RJ) is theoretically unbounded and Gaussian in distribution, while Deterministic Jitter (DJ) is bounded and does not follow any predictable distribution.

Q-Tech utilizes the EZJIT Plus jitter analysis software with Noise reduction software that supports Agilent Infinium real-time oscilloscope. Measure at its maximum sampling rate 40Gs/s and memory depth, we can separate the signal's aggregate total jitter into Random Jitter (RJ) and Deterministic Jitter (DJ).

Since Random Jitter is unbounded and Gaussian in style, the Total Jitter is a function of Bit Error Rate (BER).

$$TJ = RJ + DJ$$

Where:

$$RJ = RJ(rms) \times 2\alpha + DJ(p-p)$$

BER	α
10E-3	3.1
10E-6	4.75
10E-9	6
10E-12	7.0

Typical Jitter at BER=10E-12

Frequency	DJ (p-p) ps	RJ (rms) ps	TJ ps
16MHz (5.0V)	2.7	3.6	54.3
32MHz (3.3V)	1.97	1.13	18.1
40MHz (3.3V)	2.2	1.14	18.5
50MHz (5.0V)	1.65	1.18	18.4
100MHz (3.3V)	1.25	0.95	14.8
125MHz (3.3V)	1.15	0.96	14.9

Typical Phase Noise

Frequency	10Hz	100Hz	1kHz	10kHz	100kHz	1MHz	Phase Jitter (ps) *
16MHz	-91	-122	-147	-158	-162	-166	0.79
32MHz	-77	-109	-133	-141	-145	-153	0.33
40MHz	-79	-110	-130	-141	-145	-152	0.31
125MHz	-74	-106	-133	-141	-146	-153	0.15



Figure 1: Jitter Analysis of a QT82LD-125MHZ

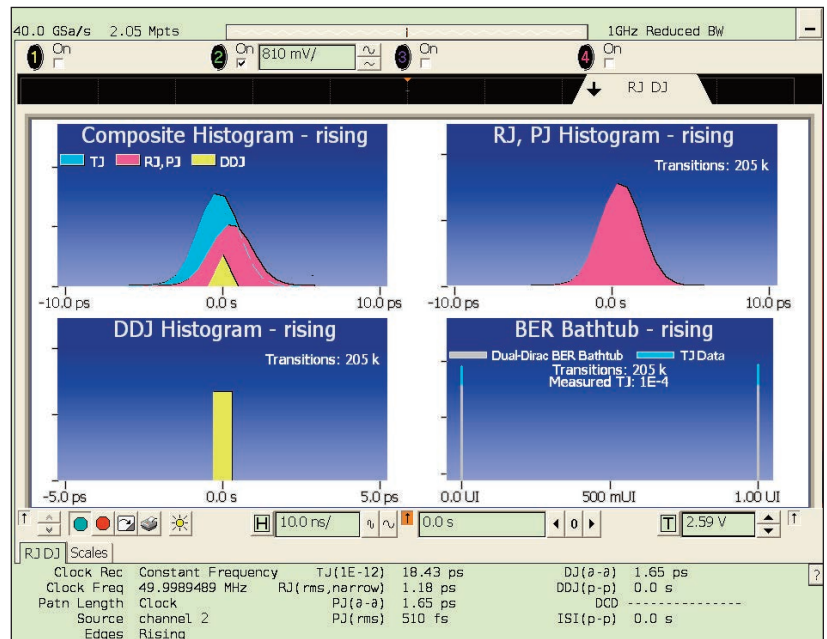

Figure 2: Jitter Analysis of a QT83HC-50MHZ

Phase Noise and Phase Jitter Integration

Phase noise is measured in the frequency domain, and is expressed as a ratio of signal power to noise power measured in a 1Hz bandwidth at an offset frequency from the carrier, e.g. 10Hz, 100Hz, 1kHz, 10kHz, 100kHz, etc. Phase noise measurement is made with an Agilent E5052A Signal Source Analyzer (SSA) with built-in outstanding low-noise DC power supply source. The DC source is floated from the ground and isolated from external noise to ensure accuracy and repeatability.

In order to determine the total noise power over a certain frequency range (bandwidth), the time domain must be analyzed in the frequency domain, and then reconstructed in the time domain into an rms value with the unwanted frequencies excluded. This may be done by converting $L(f)$ back to $S_{\phi}(f)$ over the bandwidth of interest, integrating and performing some calculations.

Symbol	Definition
$\int L(f)$	Integrated single side band phase noise (dBc)
$S_{\phi}(f) = (180/\pi) \times \sqrt{2} \sqrt{L(f)} df$	Spectral density of phase modulation, also known as RMS phase error (in degrees)
RMS jitter = $S_{\phi}(f) / (f_{osc} \cdot 360^\circ)$	Jitter (in seconds) due to phase noise. Note $S_{\phi}(f)$ in degrees.

The value of RMS jitter over the bandwidth of interest, e.g. 10kHz to 20MHz, 10Hz to 20MHz, represents 1 standard deviation of phase jitter contributed by the noise in that defined bandwidth.

Figure below shows a typical Phase Noise/Phase jitter of a QT82LD10M, 3.3Vdc, 32MHz and QT83HCD10M, 5.0Vdc, 40MHz clock at offset frequencies 10Hz to 1MHz, and phase jitter integrated over the bandwidth of 12kHz to 1MHz.

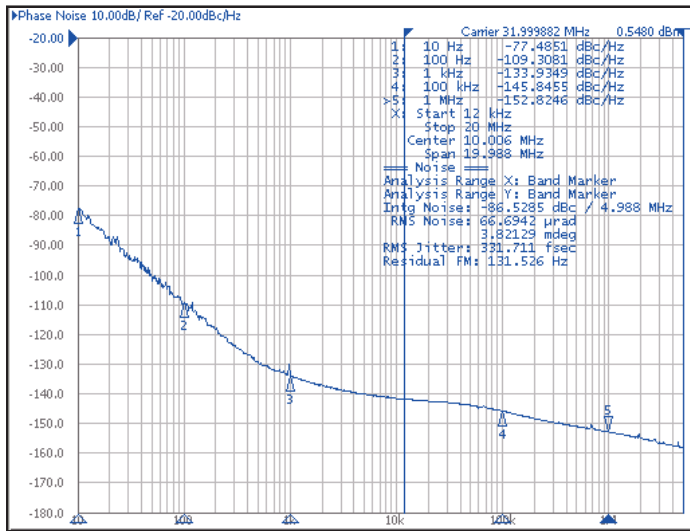

QT82LD10M, 3.3Vdc, 32MHz

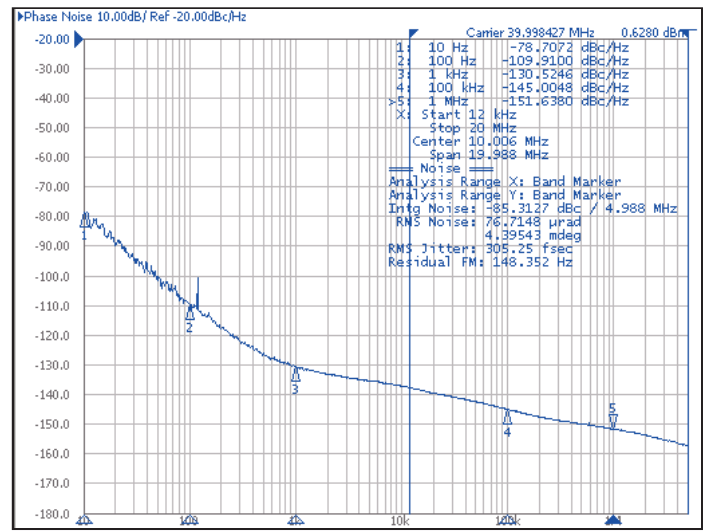

QT83HCD10M, 5.0Vdc, 40MHz



Revision History

ECO	REV	REVISION SUMMARY (OLD ECO FORMAT)	Page	Date
10613	F	Add Solder Dip option G	1	7/16/2012
		Add dimension tolerance to QT82 & QT83 outlines	3	
		Modified Package Material From 90% AL ₂ O ₃ to 91% AL ₂ O ₃		
10719	G	Features: Modified 36000G shock to half sine, 0.5ms	1	2/13/2013
		Ordering Information: Added Frequency vs. Temperature code 17 & 18	2	
		Change Rise and Fall Time from 30MHz to 40MHz		
10964	H	Modified Outline QT82 & QT83 Lead form dimensions	3	9/4/2013

DCO	REV	REVISION SUMMARY	Page	Date
8162	J	Edit lower end frequency to be 300kHz (was 500kHz)	All	5/2/2018
		Add Temperature Stability code 9	1	
		Add Revision Summary table with new DCO number format	7	